

Manufacturing Process Flowchart

Polyethylene Glycol 1000, NF - PO118

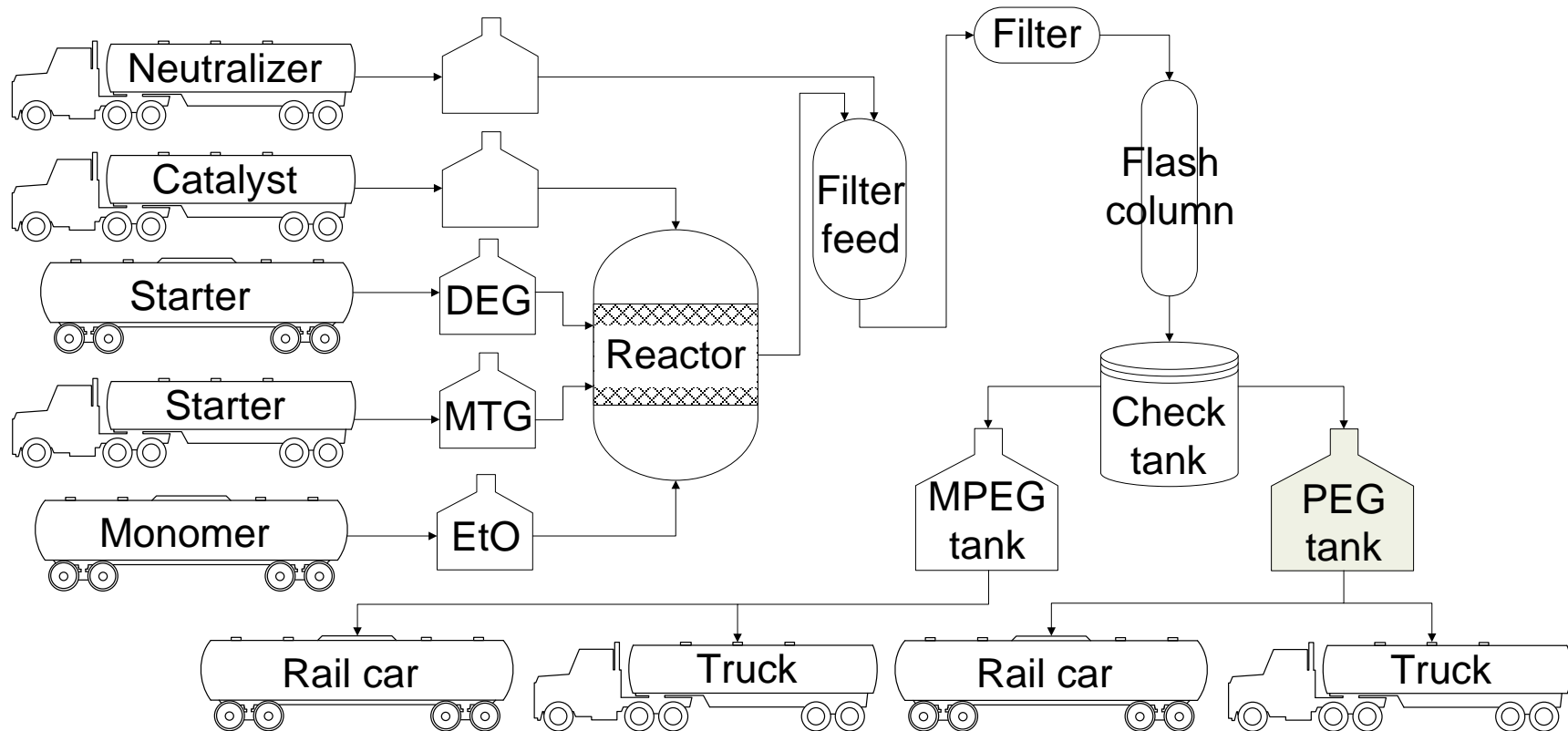

Spectrum Chemical Mfg Corp

Corporate Headquarters:

769 Jersey Ave.
New Brunswick, NJ 08901
732.214.1300

West Coast Facility:

14422 S. San Pedro St.
Gardena, CA 90248
310.516.8000